

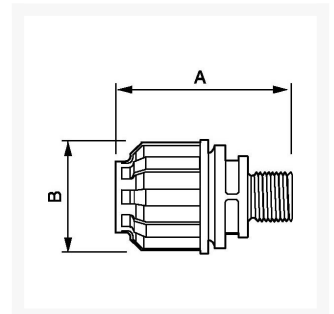

Übergangsmuffe 25 mm x 1/2" Außengewinde

Product Images



Additional Information

Artikelnummer	9ALRPM2512
EAN	08712418282801
Gewicht (kg)	0.074000
Länge (mm)	71
Breite (mm)	53
Konstruktion (Materiały)	Polyamide
Durchmesser Ø (mm)	25
Maximaldruck (bar)	13 à 40°C
Gewindegröße (")	1/2
Gewindeart	Außen

