

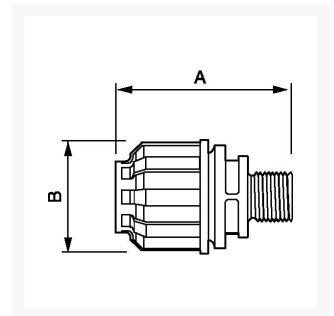

Übergangsmuffe 32 mm x 1" Außengewinde

Product Images



Additional Information

Artikelnummer	9ALRPM3234
EAN	08712418282832
Gewicht (kg)	0.121000
Länge (mm)	82
Breite (mm)	65
Konstruktion (Material)	Polyamide
Durchmesser Ø (mm)	32
Maximaldruck (bar)	13 à 40°C
Gewindegröße (")	1
Gewindeart	Außen

